

UM-35CLE

4-20mA Process Loop
3 1/2 DIGIT with 0.56" or 0.8" LEDs
in a Traditional NEMA Style Case

Easily user scaled, this meter has built-in 24V loop excitation and is ideal for 4-20mA process loop indication in any engineering unit of measure.



0.56" LEDs

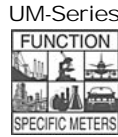

0.8" LEDs



General Features

The UM-35CLE is an economical 4-20mA process loop measuring meter with a built-in 24V DC power supply to provide loop excitation. It is easily user adjustable to any reading between -1999 and +1999 with header selectable signal conditioning.

Typical Application Connections

4 to 20mA Process Loop Measurement

Where the UM-35CLE meter provides the 24V loop excitation voltage.

Other devices can also be added to the loop.

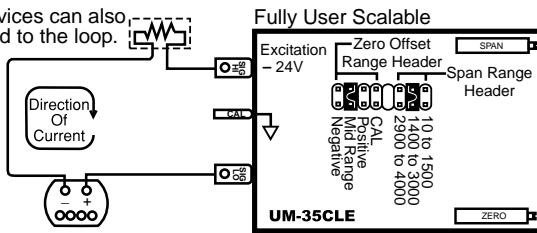

4 to 20mA Process Loop Measurement

Where the UM-35CLE meter does not provide the loop excitation voltage.

Other devices can also be added to the loop.

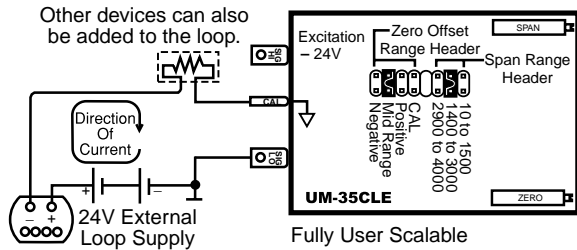

Functional Diagram

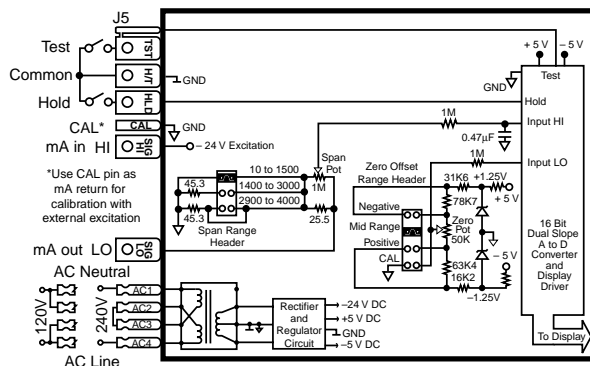

Compatibility

The UM-Series NEMA case style is complementary to Texmate's Classic RP-Series. For economy, each UM model is dedicated to a specific application. UMs are ideal for upgrading or replacing the traditional USA NEMA case panel meters presently in use.

Traditional NEMA STYLE USA CASE

Specifications

- Input Configuration:**Series connection to 4-20mA process loop. Provides 24V DC to excite the loop.
- Loop Excitation:**24V DC at 30mA. Provided by the meter.
- Full Scale Ranges:**User adjustable to any scaling between -1999 to +1999.
- Input Impedance:**70Ω. Maximum 1.4V drop
- A/D Converter:**12 bit dual slope
- Accuracy:**±(0.05% of reading + 2 counts)
- Temperature Coefficient:** 100 ppm/°C (Typical)
- Warm Up Time:**2 minutes to specified accuracy
- Conversion Rate:**3 conversions per second (Typical)
- Display:**3 1/2 digit 0.56" Red LED display (std), (optn) Green or Super Bright Red, 0.8" Red or Green. Range 0 to 1999 counts.
- Polarity:**Bipolar. Assumed positive displays negative.
- Decimal Selection:**Header under face plate, X•X•X•X•
- Overrange Indication:**1 (MSD) displayed all other digits blank
- Power Supply (std):**120/240V AC, 50/60/400 Hz. approx 1.5W. (Optn) VO-DC/ISOIsolated Switcher 9 to 36V DC/12 to 24V AC (Optn) VO-24VIsolated Transformer 24V AC ±10% (Optn) VO-5V DCNon-isolated 5V DC ±10%

- Operating Temperature:**-10 to 50 °C
- Storage Temperature:**-20 to 70 °C.
- Relative Humidity:**95% (non condensing)
- Case Dimensions:**Bezel 4.06"Wx1.89"H (102.7Wx47.9Hmm) Depth behind bezel 3.64" (92.22 mm) Plus 0.5 to .9" (12.7 to 22.8mm) depending on connector used.
- Weight:**10 oz., 13 oz when packed.

UM-Series low cost utility meters for switchboard and process indication

- UM-35AC11/5** AC amps, Scaled RMS, (1 or 5 Amp internal shunt), 3.5 digit
- UM-35AC**AC volts, Scaled RMS. **199.9V AC/500V AC** Header Selectable Ranges, 3.5 digit
- UM-40AC**AC volts, Scaled RMS. **500.0V AC** full scale, high resolution 4 digit
- UM-35HZ**15Hz to **199.9Hz** or optionally 40Hz to 500Hz up to 500V AC input, 3.5 digit
- UM-35**DC Volts ±2/20V DC Header selectable or optionally ±2/200V DC, 3.5 digit
- UM-35mV**DC mV ±50mV and ±100mV select inputs to suit DC current shunts, 3.5 digit
- UM-45**DC Volts ±2V/±20V/±200V DC Header selectable ranges 4.5 digit
- UM-45mV**DC mV ±50 mV, ±100mV, or ±200mV selectable inputs to suit DC current shunts, 4.5 digit

- UM-35CL**Process 4 to 20mA (**100.0**), easily user scalable, 3.5 digit
- UM-35CLE**Process 4 to 20mA (**100.0**) with 24V DC excitation, easily user scalable in engineering units anywhere from -1999 to +1999. 3.5 digit
- UM-45CL**Process 4 to 20mA (**100.00**), easily user scalable, 4.5 digit
- UM-35P**Pressure, strain gage and load cell, 4 and 6 wire, 5V DC excitation, Header Selectable Sensitivity 2mV/V, 5mV/V, 10mV/V, **20mV/V**, 3.5 digit
- UM-35J/K**J or K thermocouple input, 1° resolution, order °C or °F, 3.5 digit
- UM-35RTD**100Ω platinum RTD, 3 or 4 wire, order °C or °F and **0.1°** or **1°**, 3.5 digit

Connector Pinouts

UM-Series are connectable using the TB-KIT screw terminal blocks provided with the meter. For greatest convenience, order a Texmate Push-On screw terminal connector. Alternatively, a pcb edge connector can be used. (see connector options)

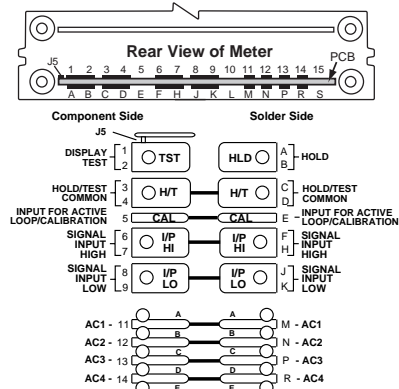

WARNING: AC and DC input signals and power supply voltages can be hazardous. Do Not connect live wires to screw terminal plugs, and do not insert, remove or handle screw terminal plugs or internal jumper clips with live wires connected to the meter.

Pins 1 & 2 - Display Test: All numeric display segments will light up when this pin is connected to the H/T Common Pin. A Texmate TB-KIT Screw Terminal Clip can be used to access the Display Test function.

Pins 3, 4, C & D - H/T Common Pin: The Hold and Display Test pins have to be connected to this pin to activate their respective functions.

Pins A & B - Hold Reading: When this pin is connected to the H/T Common pin, A/D conversions will continue, but the display will not be updated until Pins A & B are disconnected from the H/T Common pin. When using a Texmate TB-KIT Screw Terminal, J5 has to be opened to disconnect the Test function and enable the Hold function. If both hold and test functions are needed, a Push-On Screw Terminal can be used.

Pins 5 & E - CAL: Signal high input for the meter when the built-in 24V is not being used to excite the loop.

Pins 6, 7, F & H - Signal High Input: Signal high input for the meter when the built-in 24V is being used to excite the loop.

Pins 8, 9, J & K - Signal Low Input: Signal low input of the A/D Converter.

Pins 11 & M - AC1 - Live AC Power Input:

Pins 12 & N - AC2 - 110/220V AC Power Select: See below for connections

Pins 13 & P - AC3 - 110/220V AC Power Select:

Pins 14 & R - AC4 - Neutral AC Power Input:

Signal Conditioning Components

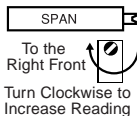

SPAN Potentiometer (Pot)

The 15 turn SPAN Pot is always on the right side (as viewed from the front of the meter). Typical adjustment is 37% of the input signal range.

SPAN ADJUST Header

This three position header enables the SPAN Pot, in three equal overlapping 37% steps, to precisely scale down the input Signal Span, to provide any required Digital Display Span. Without any scaling or offset, a 4mA to 20mA input would produce a digital output of 1000 to 5000, which is a Digital Display Span of 4000 counts.

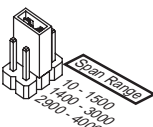

SPAN Adjust Header position	10 to 1500	1400 to 3000	2900 to 4000
SPAN Pot %	37%	37%	37%
Signal Span %	37%	75%	100%

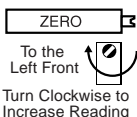
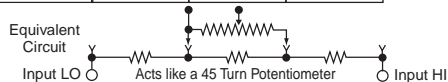

ZERO Potentiometer (Pot)

The ZERO Pot is to the left of the SPAN Pot. It enables the Digital Display Span to be offset 2000 to 2700 counts, depending on the Zero Offset Range Header position selected.

ZERO OFFSET RANGE Header

This four position header enables the ZERO Pot to offset the Digital Display Span -3000 to +2000 counts with a user selectable Negative offset, Mid-range (- & + offset), Positive offset, and a Calibrate position (ZERO Pot disengaged). The Calibrate position facilitates a simple two step calibration with no interaction between Span and Offset.

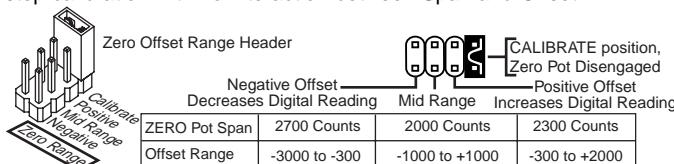

Calibration Procedure (use pins 2 & 3)

For calibration and scaling use pins 2 & 3 to bypass the 24V excitation.

The first step is to disengage the ZERO Pot and scale down the Signal Span input to produce the desired Digital Display Span output.

Signal Span is defined as the total change of signal input that would be required for a specific change of the Digital Display. The largest Signal Span that can be specified with a 4 to 20mA input is 16mA. A 4mA Signal Span proportionately scaled can meet full scale display accuracy.

Digital Display Span is defined as the exact total in counts, that the display would change within a specific Signal Span. The largest Digital Display Span that can be displayed is -1999 to +1999 (4000 counts). 16mA can not display +4000, so instead 4mA can be scaled to +1000.

The second step is to select a Zero Offset Range and offset the Digital Display Span with the ZERO Pot, until the desired reading is displayed.

Maximum offset is -3000 to +2000 counts. A Digital Display Span of 4000 counts requires an offset of -3000 to display -1999 to +1999.

For example: A 4 to 20mA input to read -40.0°C to +199.9°C
Signal Span = 16mA, Digital Display Span = 2400 counts.

1. Remove the meter from its case and set the Zero Offset Range Header to the Calibrate position. Select the 1400 - 3000 position on the Span Adjust Header and slide the meter back into the case.
2. Connect power to the meter and apply 4mA (25% of 16mA). Adjust the SPAN Pot until the display reads +600 (25% of 2400). The meter is now scaled for a Signal Span of 16mA and a Digital Display Span of 2400 counts. In the example 4mA should read -400 and 20mA read 1999, therefore the Digital Display Span should be offset by -1000.
3. Disconnect power and remove the meter from the case, select the Negative offset position on the ZERO OFFSET RANGE Header, and slide the meter back into the case.
4. Connect power to the meter, apply 4mA and adjust the ZERO Pot until the display reads -400. With the Digital Display Span now offset by -1000 counts, the meter will read -400 for a 4mA input, and read +1999 for a 20mA input. Select decimal point 1XX.X to display -40.0 to +199.9. Then apply the self adhesive °C symbol (from the Face Plate Descriptor sheet provided) to complete the calibration.

Component Layout

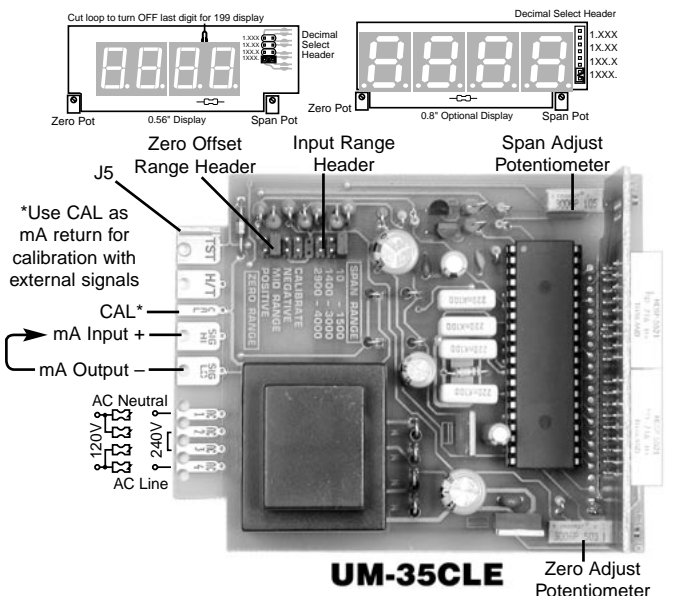

Decimal Point Selection

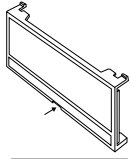

Remove faceplate by inserting a screwdriver blade in the slot at the bottom center of the faceplate. Press blade in to release catch and gently pry face plate outward from the bottom. (see also Case Dimension drawing)

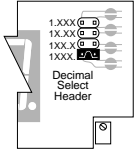

Decimal selection is made on the front of the display board by moving the jumper clip to the desired position on the header.

TB-Kit Screw Connectors

Six Screw Terminals included Free with each UM Series meter

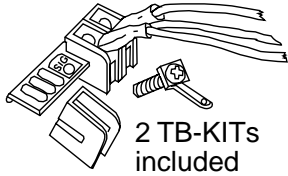

2 TB-KITs included

A TB-KIT consists of 3 insulated Quick Connects and 3 of Texmate's patented individual screw terminal blocks which attach directly to PCB inputs. These provide a Quick Connect tab and screw clamp termination. When using the TB-KIT screw terminal blocks, it is possible to

select between 120V AC and 240V AC power, the optional low voltage switching power supply or the 24V AC power supply by connecting the screw terminals as shown in the diagrams below.

Optional PCB Edge Connector

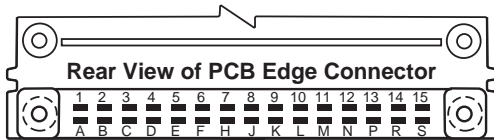

A standard 30 pin edge connector (two rows of 15 pins on 0.156" centers) may also be used to connect the UM-Series. Order part no. CN-L15. For different power supply voltage connection details, see pin connections below.

Selecting Power Supply Voltages

With TB-KIT Screw Terminals

With Optional PCB Edge Connector

For 100 to 120V AC, 50/60 Hz

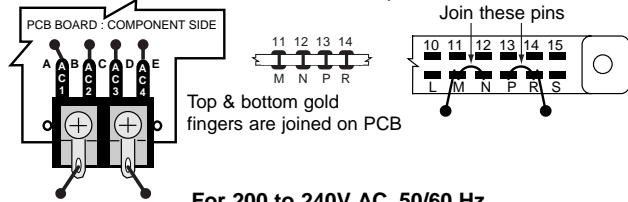

Top & bottom gold fingers are joined on PCB

For 200 to 240V AC, 50/60 Hz
or For Optional 24V AC (P.N.:V0-24V)

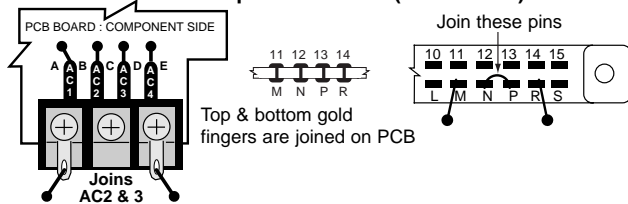

Top & bottom gold fingers are joined on PCB

For Isolated 9-36V DC/12-24V AC, 50/60 Hz
Switching Power Supply

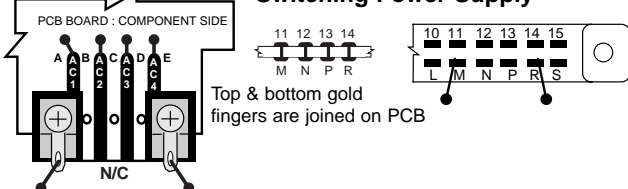

Top & bottom gold fingers are joined on PCB

Push-On Screw Terminals

They provide the greatest convenience and ease of use

Texmate's exclusive optional Push-On Connectors combine an edge card connector and a 10 position screw terminal block. Push-On Connectors are ordered preconfigured for each specific power supply voltage and each optional power supply available for the UM-Series.

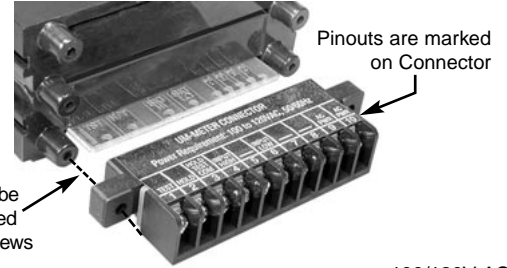

Connector can be securely attached to case with screws

Pinouts are marked on Connector

CN-PUSH/UM	100/120V AC
CN-PUSH/UM01	200/240V AC
CN-PUSH/UM02	Switch Selectable 120/240V AC
CN-PUSH/UM03	24V AC
CN-PUSH/UM04	9-36V DC/12-24V AC
CN-PUSH/UM05	5V DC

Pinout Change-Over Connectors

To replace DPMs in existing panels where matching pinouts are required, Texmate can provide custom pinout Change-over Connectors, either with PCB gold finger terminations, (shown below) or customized versions of Push-On Screw Terminals. (shown above)

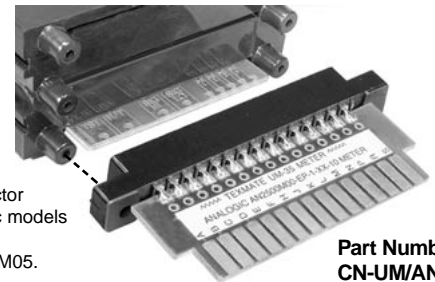

Change-over Connector shown is for Analogic models AN25M02, AN25M03, AN25M04 and AN25M05.

Part Number CN-UM/ANLGC

Face Plate Descriptors

Volts AC	Volts DC	Hz	RPM
Amps AC	Amps DC	DCµA	
Milliamps AC	Milliamps DC	°C	
Millivolts AC	Millivolts DC	°F	
Kilowatts	Watts	%	pH
kg/cm ²	Kilovolts AC	psi	
kWH	kVAR	Power Factor	
kΩ	CosØ	M/min	m ³ /hr

To customize the face plate, each UM-meter is supplied with a white printed clear adhesive label containing various popular descriptors. Choose the descriptor, peel off the adhesive backing and align the descriptor in the lower right corner of the standard face plate.

Custom Face Plates

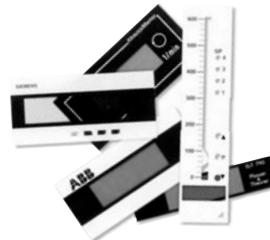

Texmate Produces Thousands of Custom OEM Face Plates

Have Texmate Design and produce a Custom Face Plate for your next project!

- Custom face plates have a non-recurring artwork charge. A serial number is then assigned to each artwork to facilitate reordering.

- Small Run or One-Off custom face plates incur an installation charge, and are generally printed on a special plastic film, which is then laminated to custom faceplate blanks as required.

- Large Run (250 pieces min): custom face plates are production silk screened, issued a part number, and held in stock for free installation as required by customer orders.

- OEMs may also order Custom Meter Labels, Box Labels, Custom Data Sheets and Instruction Manuals.

UM Case Dimensions and Panel Cutouts

This NEMA Case will fit any existing cutout with dimensions that are between the Snug and Loose Fitting dimensions shown below.

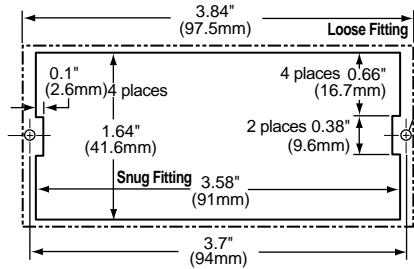

Panel Cutout for Front Panel Removal

To enable removal of the panel meter from a mounting panel without requiring rear access, make the panel cutout as shown above, using the mounting plate supplied with the meter as a template. The mounting holes should then be tapped to match the mounting screws.

To remove the face plate, carefully insert screwdriver blade at bottom slot to release catch and gently pry outward to release the plate.

For new installations see Optimum Panel Cutout or Panel Cutout for Front Panel Removal

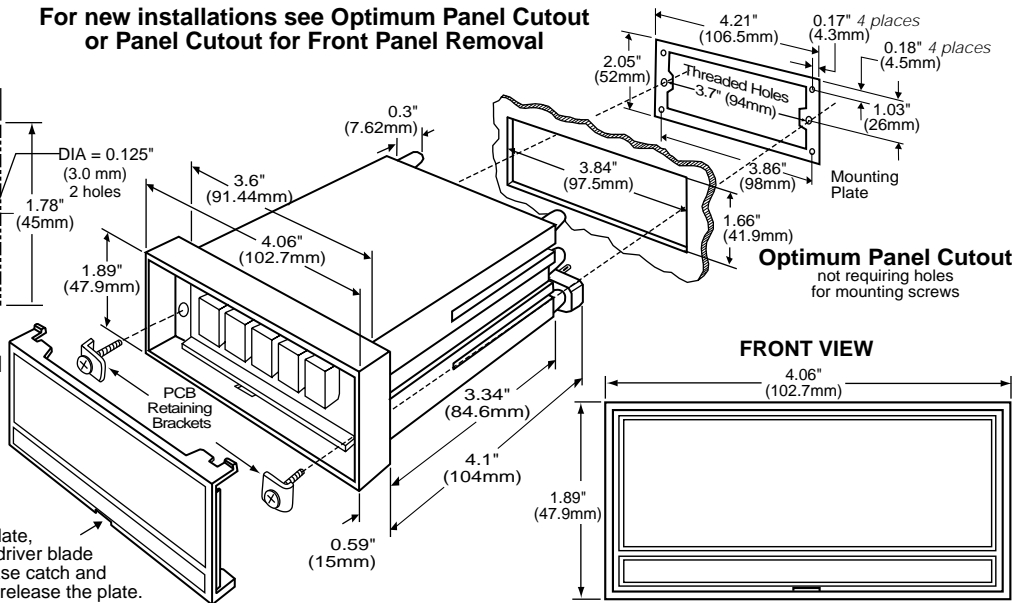

Ordering Information

Standard Options for this Model Number

Part Number	Description	List
► BASIC MODEL NUMBER Includes 2 TB-KITs, standard display and standard power supply unless optional versions are ordered.		
UM-35CLE.....	DPM, Process 4-20mA w/24VDC Exc.....	\$89
► DISPLAY		
STANDARD	0.56" Red LEDsN/C
UM-BRIGHT	Super bright Red LEDs, 0.56 inch high	\$20
UM-GREEN	Green LEDs, 0.56 inch high	\$10
UM-GREEN4.5	Green LEDs, 0.56 inch high Dummy Zero Option for UM-35s	\$25
UM-LARGE/GRN	Green LEDs, 0.8 inch high for UM-35 Series	\$35
UM-LARGE/RED.....	Red LEDs, 0.8 inch high for UM-35 Series	\$25
UM-RED4.5.....	Red LEDs, 0.56 inch high Dummy Zero Option for UM-35s	\$25
► POWER SUPPLY		
STANDARD	100/120 or 200/240VAC User selectableN/C
V0-DC/ISO	Isolated auto-sensing AC/DC 9 to 36V DC/12 to 24V AC	\$35
V0-24V.....	Isolated transformer 12V AC or 24V AC user selectable	\$15
► SPECIAL OPTIONS (Specify Inputs or Outputs & Req. Reading)		
HD-CHANGE	Range change from the standard input as shown in BOLD type...\$7	
V0-50K	Zero offset Potentiometer 50K	\$5
CB-FS35	Non-Std Range and Scale changes for UM-35 meters	\$10

WARRANTY

Texmate warrants that its products are free from defects in material and workmanship under normal use and service for a period of one year from date of shipment. Texmate's obligations under this warranty are limited to replacement or repair, at its option, at its factory, of any of the products which shall, within the applicable period after shipment, be returned to Texmate's facility, transportation charges pre-paid, and which are, after examination, disclosed to the satisfaction of Texmate to be thus defective. The warranty shall not apply to any equipment which shall have been repaired or altered, except by Texmate, or which shall have been subjected to misuse, negligence, or accident. In no case shall Texmate's liability exceed the original purchase price. The aforementioned provisions do not extend the original warranty period of any product which has been either repaired or replaced by Texmate.

Special Options and Accessories

Part Number	Description	List
► ACCESSORIES (Specify Serial # for Custom Artwork Installation)		
75-RPCLEAR	Replacement Clear Lens for meter	\$2
75-RPFILTER	Replacement Red Lens for meter	\$2
CN-L15	Connector: Dual Row, 30 Pin Edge Conn., 0.156" ctr	\$4
CN-PUSH/UM	Connector: Push-on Terminal Block, 120V AC Pwr	\$18
CN-PUSH/UM01	Connector: Push-on Terminal Block, 200-240V AC Pwr	\$18
CN-PUSH/UM02	Connector: Push-on Terminal Block, 120/240V AC select.	\$20
CN-PUSH/UM03	Connector: Push-on Terminal Block, 24V AC pwr	\$18
CN-PUSH/UM04	Connector: Push-on Terminal Block, 9 to 36V DC/12 to 24V AC	\$18
CN-PUSH/UM05	Connector: Push-on Terminal Block, 5V DC	\$18
CN-UM/ANLGC	Connector: Pinout Changer to match Analogic AN20M02 etc	\$30
OP-N4SEAL/UM	NEMA 4 lens cover for UM Series meters	\$50
RP•CASE	Case: Replacement with Mounting Hardware	\$10
TB-KIT	Connector: xtra Screw Terminal Blocks (3 sets=1 kit)	\$1
ART-FS-S/D	NRC for Artwork & set-up Custom Faceplate and or Descriptor	\$35
ART-FS-S/D/C	NRC for Artwork & set-up Custom Faceplate and Custom Logo	\$75
ART-FS-001	Produce & Install Custom Faceplate per meter - 1 color no-min \$10	\$20
ART-FS-002	Produce & Install Custom Faceplate per meter - 2 color no-min	\$20
ART-FS-003	Produce & Install Custom Faceplate per meter - 3 color no-min	\$30
ART-FUM-001	Custom Faceplate, 100 piece Min. (\$3.00 each) - 1 color	\$300
ART-FUM-002	Custom Faceplate, 100 piece Min. (\$4.20 each) - 2 color	\$420
ART-FUM-003	Custom Faceplate, 100 piece Min. (\$5.40 each) - 3 color	\$540

Many other options and accessories are available. See full price list for more details.
Prices subject to change without notice.

USER'S RESPONSIBILITY

We are pleased to offer suggestions on the use of our various products either by way of printed matter or through direct contact with our sales/application engineering staff. However, since we have no control over the use of our products once they are shipped, NO WARRANTY WHETHER OF MERCHANTABILITY, FITNESS FOR PURPOSE, OR OTHERWISE is made beyond the repair, replacement, or refund of purchase price at the sole discretion of Texmate. Users shall determine the suitability of the product for the intended application before using, and the users assume all risk and liability whatsoever in connection therewith, regardless of any of our suggestions or statements as to application or construction. In no event shall Texmate's liability, in law or otherwise, be in excess of the purchase price of the product.

Texmate cannot assume responsibility for any circuitry described. No circuit patent or software licenses are implied. Texmate reserves the right to change circuitry, operating software, specifications, and prices without notice at any time.



995 Park Center Drive • Vista, CA 92081-8397

Tel: 1-760-598-9899 • USA 1-800-839-6283 • That's 1-800-TEXMATE

Fax: 1-760-598-9828 • Email: sales@texmate.com • Web: www.texmate.com

Texmate has facilities in Japan, New Zealand, Taiwan, and Thailand. We also have authorized distributors throughout the USA and in 28 other countries.

For product details visit www.texmate.com

Local Distributor Address