

Features

- Extensive range
- High accuracy 0.5%
- Up to 3 analogue outputs in one housing
- Zero and span adjustments
- DIN rail mounting
- Single and 3 phase systems
- Flame retardant cases
- Screw clamp terminals

Benefits

- Cost saving remote metering
- Reduction of signal levels for ease of metering
- Isolated output for safety
- Protection against high voltage and overload

Applications

- Switchgear
- Distribution systems
- Generator sets
- Control panels
- Energy management
- Building management
- Utility power monitoring
- Process control
- Motor control

Approvals

- UL File No: E140758
- CSA File No: LR52592
- BV File No: 3896H-07425-AO PRSO BV

An extensive range of Class 0.5 transducers providing measurement, isolation and conversion of electrical parameters into industry standard DC output signals. The range offers protection against high voltage and overload, and resistance to vibration in harsh electrical environments. Transducers offer multiple analogue outputs from one housing, and individual measurement of most electrical parameters.

Introduction

Crompton transducers can be used for measuring most electrical parameters. The following transducers can be supplied:

- A.C. and D.C. current and voltage.
- Active, reactive and apparent power.
- Frequency.
- Power Factor and Phase Angle.
- Integrating current for maximum demand indication and Alarm Control.
- Suppressed zero voltage for monitoring a narrow voltage range.
- Tap position on a high voltage transformer.
- Temperature transmitters for thermocouples and resistance thermometer detectors (RTD's).
- Resistance (slidewire) transmitters.

Safety Features

Crompton transducers and transmitters are designed for use in harsh electrical environments and feature:

- High protection against overload - 20 x rated current for 1 second.
- High degree of mechanical shock and vibration resistance.
- Protection against high voltage.
Inputs, outputs and power supply are galvanically isolated from one another (excluding Resistance transmitters).

Application

- Measurement of most electrical parameters.
- Conversion to standard d.c. output signals.
- Outputs suitable for indication, PLC's.
- For use in Control Cabinets, Switchboards, Motor Control Centres, Generating Sets, Energy Management & Building Management systems.

Ordering Information

When ordering please specify:

1. Product catalogue number.
2. Current and/or voltage.
3. Frequency.
4. Auxiliary voltage A.C. or D.C.
5. Options e.g. calibration at 30°C.
6. For power products:
 - a. V.T. & C.T. ratios.
 - b. System configuration i.e. Single Phase, 3 Phase 3 or 4 Wire, balanced or unbalanced load.
7. For slide wire transmitters quote R1, R2 and R3, see page G9.
8. National Specification:
Indicated by 7th letter of part number.

Information provided by:

MetersUSA

Meters@MetersUSA.com

WWW.MetersUSA.com

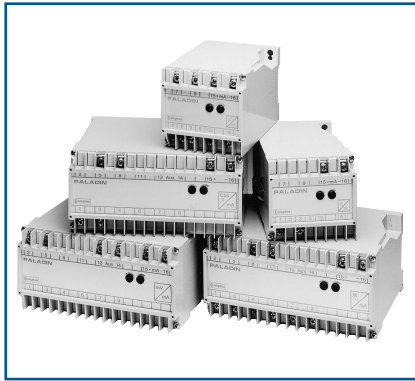

Information provided by:
MetersUSA
Meters@MetersUSA.com
WWW.MetersUSA.com

Specification

Performance	Designed to comply with BS6253 part 1, EN60688, IEC688, AS1384 and ANSI. C37.
Temperature Range:	Storage -20°C to +70°C Operating 0°C to +60°C Calibrated at 23°C
Temperature Coefficient:	0.03%/ per °C
Humidity Range:	Up to 95% RH
Zero Adjustment:	±2% minimum (except TAA & TVA)
Span Adjustment:	±10% minimum
Accuracy Class:	0.5 unless otherwise specified
Accuracy Range:	0 to 125% (except self powered)
Stability:	+0.25% per annum (reducing with time)
Test Voltage:	2kV ms to ANSI, C37
Response Time:	<400ms from 0 to 99% of rated output, 250 ms to 90%
D.C. outputs (Typical):	0/1mA into 0-10kΩ 0/5mA into 0-2kΩ 0/10mA into 0-1kΩ 0/20mA into 0-500Ω (600Ω available on selected models) 4/20mA into 0-500Ω (600Ω available on selected models) 0/5V 1k ohm minimum load 0/10V 1K ohm minimum load - bipolar for some models
Current Output Protection:	Fully protected against open and short circuited output
Voltage Output Protection:	Fully protected against open circuit output
Maximum output:	20V d.c. when open circuit
Output Ripple:	<0.5% of full rated output
Overload Capacity:	2 x rated current continuous 1.25 x rated voltage continuous 20 x rated current for 1 second 1.5 x rated voltage for 10 seconds
Input Impedance: (d.c. I/P)	d.c. 1000 ohms/volt as standard 10k ohms/volt available on request
Input Burden:	a.c. <2VA
Auxiliary Burden:	<2VA a.c., <3.5W d.c. auxiliary voltage variation: ±20% a.c., ±15% d.c., maximum 14% ripple
Safety:	To IEC1010 with terminal cover, basic insulation category
Minimum Test Voltage:	2kV rms for 1 minute
Flammability:	Flame retardant
Isolation:	Input/Output/Supply/Case (except TRR, TRP, TRT and TRV with no input/output isolation)
Interference:	Electrical stress surge withstand to IEC 688 part of IEC 801 and ANSI C37 90a
Immunity:	Impulse test 5kV transient to IEC688 and IEC801
Enclosure:	IP50 to BS5490, IEC529 when the terminal cover is fitted. The case is UL94V0 and the terminal cover is UL94V2
Fixing:	EN50022
Approvals:	EMC and LVD UL recognised File No: E140758 CSA recognised File No: LR52592 BV File No: 3896H-07425-AO PRSO BV

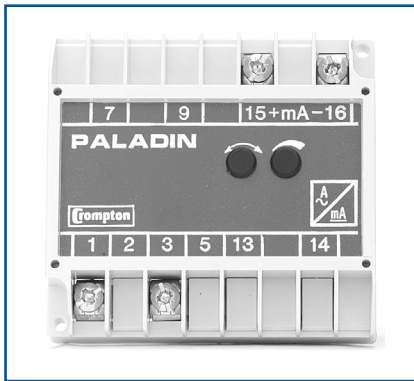

Information provided by:
MetersUSA
Meters@MetersUSA.com
WWW.MetersUSA.com

A.C. Current Average Sensing - Self Powered

Current measuring applications to 0.5% accuracy. Average sensing and calibrated to indicate the RMS value of a sine wave with less than 1% distortion. Internal power is derived from the input signal. Input and output are isolated.

Specification

Inputs:	1, 5 or 10A A.C. 50 or 60 Hz
Auxiliary Power:	Self Powered
Output:	0/1mA, 0/5mA, 0/10mA and 0/20mA

Product Code – Single Phase Current Transducer - 1 D.C. Output

Input A.C.	Aux Power	O/P D.C.	Catalogue No.	Connection Diag.
5A 60Hz	Self	0/1mA	253-TAA*-LSFA-C6	1

Product Code – 3 Phase Current Transducer - 3 D.C. Output

Input A.C.	Aux Power	O/P D.C.	Catalogue No.	Connection Diag.
5A 60Hz	Self	0/1mA	256-TAA*-LSFA-C6	47

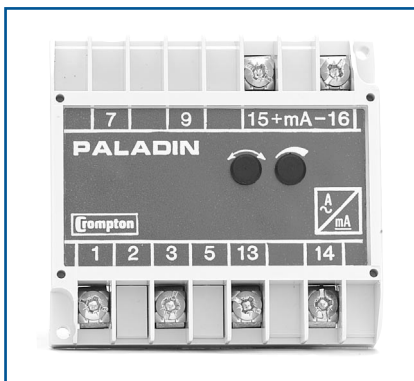

A.C. Current Average Sensing - Auxiliary Powered

Single or three phase models offering current measurement down to zero input. Model TAL provides a current output with a live zero (4-20mA). Average sensing and calibrated to indicate the RMS value of a sinewave with up to 1% distortion, isolation is provided between input, output and auxiliary.

Specification

Inputs:	1, 5 or 10A A.C. 50 or 60 Hz
Output:	0/1mA, 0/5mA, 0/10mA, 0/20mA, 4/20mA
Auxiliary Power:	A.C.: 63.5, 100, 110, 120, 220, 240, 250, 380, 400, 415, 440 and 480V D.C.: 12, 24, 48, 110, 120 or 135V nominal

Product Code – Single Phase Current Transducer - 1 D.C. Output

Input A.C.	A.C. Aux Power	O/P D.C.	Catalogue No.	Connection Diag.
5A 60Hz	120V	4/20mA	253-TAL*-LSHG-C6-DG	6

Product Code – 3 Phase Current Transducers - 3 D.C. Outputs

Input A.C.	A.C. Aux Power	O/P D.C.	Catalogue No.	Connection Diag.
5A 60 Hz	120V	0/1mA	256-TAS*-LSFA-C6-DG	2
5A 60 Hz	120V	4/20mA	256-TAL*-LSHG-C6-DG	2

With multiple analogue outputs, do not common the -ve terminals.

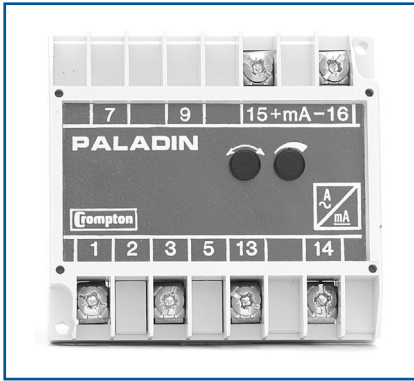

Information provided by:
MetersUSA
Meters@MetersUSA.com
WWW.MetersUSA.com

True RMS Current

True RMS measurement of the input current, measuring non standard and distorted waveforms. Calibration is correct for sine waves having up to 30% of 3rd harmonic distortion. Isolation is provided between input, output and auxiliary.

Specification

Inputs:	1.5 or 10A A.C., 50 or 60 Hz Refer to factory for other inputs
Output:	0/1mA, 0/5mA, 0/10mA, 0/20mA, 4/20mA
Auxiliary Power:	A.C. 63.5, 100, 110, 120, 220, 240, 250, 380, 400, 415, 440 and 480V D.C. 12, 24, 48, 110, 120, or 135V

Product Code – Single Phase Current Transducer

Auxiliary Powered - 1 D.C. output.

Input A.C.	A.C. Aux Power	O/P D.C.	Catalogue No.	Connection Diag.
5A 60HZ	120V	0/1mA	253-TAR*-LSFA-C6-DG	6

Product Code – 3 Phase Current Transducers

Auxiliary Powered - 3 D.C. outputs.

Input A.C.	A.C. Aux Power	O/P D.C.	Catalogue No.	Connection Diag.
5A 60HZ	120V	0/1mA	256-TAR*-LSFA-C6-DG	2

With multiple analogue outputs, do not common the -ve terminals.

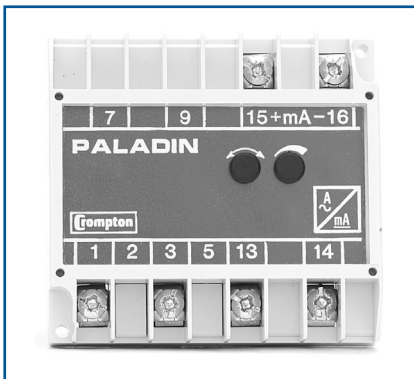

Integrating Demand

RMS calibration, conveniently averages fluctuating input signals into a steady signal. The A.C. input model can provide a maximum demand monitor with 8, 15 or 30 minute integration periods. The D.C. input model can accept the output from other transducers e.g. Watt for indicating integrated power, or RTD for average temperature.

Specification

Inputs:	1 or 5A a.c., 50 or 60 Hz 0/1mA, 0/20mA, d.c. 0/5mA, 0/10mA, 0/20mA, 0/1V, 0/10V d.c.
Auxiliary Power:	63.5, 110, 120, 220, 240, 280, 415, 440, 480V a.c.

Product Code – Single Phase A.C. Integrating Demand Current Transducer

Auxiliary Powered - 1 D.C. Output.

Input A.C.	Time Constant	O/P D.C.	Catalogue No.	Connection Diag.
5A 60Hz	8 Minutes	0/1mA	253-TAP*-LSFA-C6-DG	8
5A 60Hz	15 Minutes	0/1mA	253-TAN*-LSFA-C6-DG	8
5A 60Hz	30 Minutes	0/1mA	253-TAM*-LSFA-C6-DG	8

Product Code – D.C. Integrating Demand Transducer

Auxiliary Powered - 1 D.C. Output.

Input D.C.	Time Constant	O/P D.C.	Catalogue No.	Connection Diag.
1mA	8 Minutes	0/1mA	253-TDP*-FAFA-DG	4
1mA	15 Minutes	0/1mA	253-TDN*-FAFA-DG	4
1mA	30 Minutes	0/1mA	253-TDM*-FAFA-DG	4

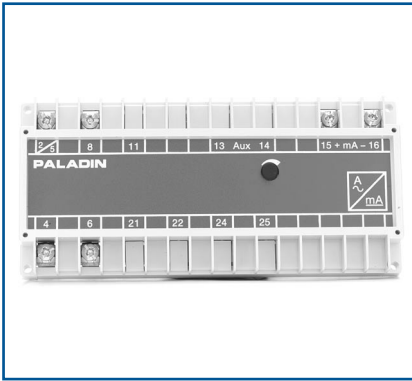

A.C. Current Bi-Directional

This transducer shows the magnitude and direction of an A.C. input current.

Specification

Inputs:	Voltage: 63.5, 100, 110, 120, 220, 240, 250, 380, 400, 415 and 480V a.c., 50 or 60 Hz Current: 1 or 5A, 50 or 60 Hz
Auxiliary Power:	Self powered
Outputs:	±1mA/5mA/10mA/20mA

Product Code – Single or 3 Phase System, Self Powered, 1 D.C. Output

Input A.C.	A.C. Aux Power	O/P D.C.	Catalogue No.	Connection Diag.
120V, 5A, 60Hz	Self	+/-1mA	256-TAB*-LSM1-C6-PQ-T3	3



A.C. Voltage Average Sensing - Self Powered

Standard version for use in all voltage measuring applications. Average sensing for normal sinewave voltages, RMS calibrated for sinewave with up to 1% of 3rd harmonic distortion. Will allow measurement down to 20% of full input. The input signal provides operational power, thus avoiding the need for a separate supply. The input is isolated from the output.

Specification

Inputs:	63.5, 100, 110, 120, 220, 240, 250, 380, 400, 415, 440V and 480V a.c. 50 or 60 Hz
Range:	20 to 125%
Auxiliary Power:	Self Powered
Outputs:	0/1mA, 0/5mA, 0/10mA and 0/20mA

Product Code – Single Phase, Self Powered, 1 D.C. Output

Input A.C.	Aux Power	O/P D.C.	Catalogue No.	Connection Diag.
120V 60Hz	Self	0/1mA	253-TVA*-PQFA-C6	10

Information provided by:
MetersUSA
Meters@MetersUSA.com
WWW.MetersUSA.com



A.C. Voltage Average Sensing - Auxiliary Powered

Auxiliary power allows measurement of voltages down to zero. Average sensing and calibrated to indicate the RMS value of a sinewave with up to 1% distortion. Model TVL provides a voltage input with a live zero (4-20mA). All models have input and output isolation.

Specification

Inputs:	63.5, 100, 110, 120, 220, 240, 250, 380, 400, 415, 440 and 480V a.c., 50 or 60 Hz
Output:	0/1mA, 0/5mA, 0/10mA, 0/20mA, 4/20mA
Auxiliary Power:	A.C. 100, 110, 120, 220, 240, 250, 380, 400, 415, 480V D.C. 12V, 24V, 48V, 110V, 120V or 135V

Product Code - Single Phase - Live Zero - A.C. Voltage Transducer, Auxiliary Powered - 1 D.C. Output

Input A.C.	A.C. Aux Power	O/P D.C.	Catalogue No.	Connection Diag.
120V	120V	4/20mA	253-TVL*-PQHG-C6-DG	15

Product Code - 3 Phase - Live Zero - A.C. Voltage Transducer, Auxiliary Powered - 3 D.C. Outputs

Input A.C.	System	O/P D.C.	Catalogue No.	Connection Diag.
120V	3 Phase 3 wire	4/20mA	256-TVL*-PQHG-C6-DG	11
120V	3 Phase 4 wire	0/1mA	256-TVS*-PQFA-C6-DG	11

With multiple analogue outputs, do not common the -ve terminals.

Information provided by:
MetersUSA
Meters@MetersUSA.com
WWW.MetersUSA.com

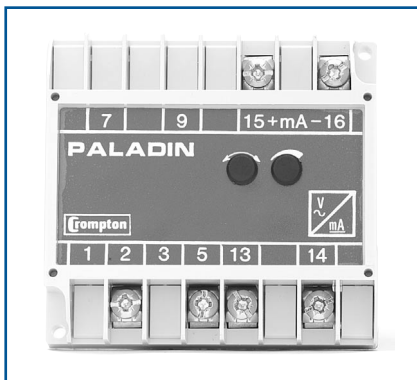

A.C. Voltage Suppressed Zero - Expanded Scale

Allows 'expanded scale' measurements at critical voltage levels, indicating small changes within a large voltage span. Average sensing and RMS calibrated, isolation is provided between input and output.

Specification

Inputs:	Between $\pm 10\%$ and $\pm 30\%$ of nominal 63.5, 100, 110, 120, 139, 208, 220, 240, 250, 277, 380, 400, 415, 440V and 480V a.c. 50 or 60 Hz
Outputs:	0/1mA, 0/5mA, 0/10mA, 0/20mA d.c.

Product Code - Single Phase - Suppressed Zero - A.C. Voltage Transducer, Self Powered - 1 D.C. Output

Input A.C.	A.C.Aux Power	O/P D.C.	Catalogue No.	Connection Diag.
108 - 132V	Self	0/1mA	253-TVZ*-A9FA-C6	15

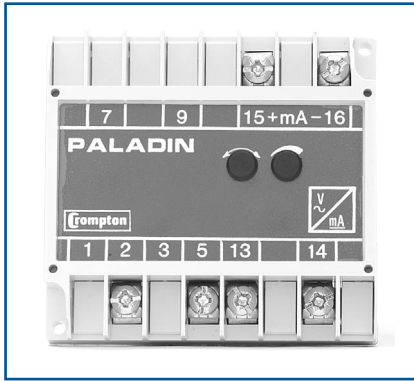

True RMS A.C. Voltage

Single or 3 phase true RMS voltage measurement down to zero. Calibration is maintained for sinewaves having up to 30% of 3rd harmonic distortion. Isolation is provided between input and output.

Specification

Inputs:	63.5, 100, 110, 120, 220, 240, 250, 380, 400, 415, 440V and 480V A.C., 50 or 60 Hz
D.C. Outputs:	0/1mA, 0/5mA, 0/10mA, 0/20mA, 4/20mA
Auxiliary Power:	A.C.: 100, 110, 120, 220, 250, 380, 400, 415 and 480V. D.C.: 12V, 24V, 48V, 110V, 120V or 135V

Product Code – Single Phase. Voltage Transducer, Auxiliary Powered - 1 D.C. Output

Input A.C.	A.C.Aux Power	O/P D.C.	Catalogue No.	Connection Diag.
120V 60Hz	120V	0/1mA	253-TVR*-PQFA-C6-DG	15

Product Code – 3 Phase. Voltage Transducers

Auxiliary Powered - 3 D.C. outputs.

Input A.C.	A.C.Aux Power	O/P D.C.	Catalogue No.	Connection Diag.
120V 60Hz	120V	0/1mA	256-TVR*-PQFA-C6-DG	11

With multiple analogue outputs, do not common -ve terminals.

Information provided by:
MetersUSA
Meters@MetersUSA.com
WWW.MetersUSA.com



Frequency Transducer

A simple reliable transducer for the measurement of AC power frequencies, and to provide a DC output which is directly proportional to the change of input within a specified span. Isolation is provided between input and output. Ideally suited for process control monitoring, data acquisition, mains and genset applications.

Specification

Frequency:	45-55Hz, 55-65Hz, 45-65Hz, 360-440Hz
Inputs:	63.5, 100, 110, 120, 220, 230, 240, 380, 400, 415, 440, and 480V 50 or 60 Hz. Refer to factory for other inputs
Outputs:	0/1mA, 4/20mA, 0/5mA, 0/10mA, 0/20mA
Auxiliary Powered:	Self Powered
Accuracy:	0.1% of mid Frequency

Product Codes – Single Frequency Transducer, Self Powered - 1 D.C. Output

Input A.C.	Frequency	O/P D.C.	Catalogue No.	Connection Diag.
120V	45/55Hz	0/1mA	253-THZ*-PQFA-AG	10
120V	55/65Hz	0/1mA	253-THZ*-PQFA-AN	10
120V	45/65Hz	0/1mA	253-THZ*-PQFA-AJ	10
120V	360/440Hz	0/1mA	253-THZ*-PQFA-BI	10

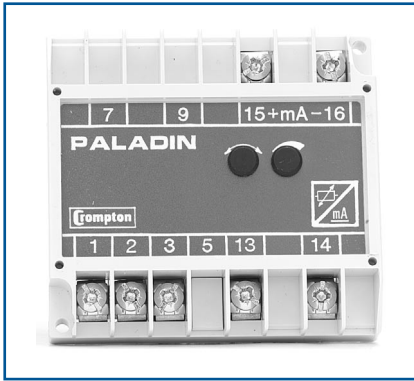

Information provided by:
MetersUSA
Meters@MetersUSA.com
WWW.MetersUSA.com

Tap Position Transmitter

For accurate remote indication of tap position selection on a high voltage transformer. The variable tap position voltage is monitored, a D.C. output produced which is proportional to the tap position.

Specification

Input Span:	1-20k 5-50 taps at 400Ω each 10-50 taps at 30Ω each
Outputs:	0/1mA, 0/5mA, 0/10mA, 0/20mA, 4/20mA
Auxiliary Power:	A.C. 110, 120, 220, 240, 380, 415V 63.5, 139, 208, 277, 440, 480V D.C. 12, 24, 48, 120, 135V

Product Codes – Tap Position Transmitter, Auxiliary Powered

Taps	Ohm	O/P D.C.	Catalogue No.	Connection Diag.
10-50	30	0/1mA	253-TRT*-TIFA-DG	12
5-50	400	0/1mA	253-TRT*-T5FA-DG	12

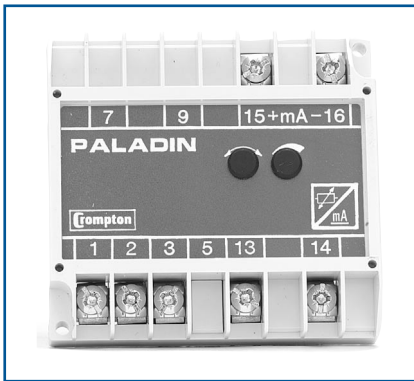

Slide Wire Transmitter

Designed for accurate measurements and transmission of resistance ratio of a 3 wire potentiometer. A stabilised voltage is applied to the potentiometer and the voltage measured from the zero to the end of the wiper. This is amplified and the D.C. output produced is proportional to the resistance value.

Specification

Input Span:	Minimum 1kΩ Max 50kΩ Specify values of R1, R2, R3 Example for 1k Potentiometer: R1 = 1k, R2 = 0, R3 = 1k Example for 5k Potentiometer using only 4k; R1 = 5k, R2 = 1k, R3 = 4k (Remember R1 = R2 + R3)
Outputs:	0/1mA, 0/5mA, 0/10mA, 0/20mA or 4-20mA, 0/1, 0/5, 0/10V D.C.
Auxiliary Power:	A.C. 110, 120, 220, 240, 380, 415V, 63.5, 139, 208, 277, 440, 480V D.C. 12, 24, 48, 110, 120 or 135V

Note:

Not all applications provide for the slider to mechanically travel the full distance along the resistor track. Normally the first resistor step is inside the transducer and its value should be stated when ordering, as well as the total track resistance. End of track or connecting lead resistance, if significant, should also be considered. For satisfactory operation, the change in resistance should be greater than 20% of the total resistance.

Product Code – Side Wire Transmitter (3 wire), Auxiliary Powered

Input (Specify)	A.C. Aux Power	O/P D.C.	Catalogue No.	Connection Diag.
R1, R2, R3	120V	0/1mA	253-TRP*-TRFA-DG	12

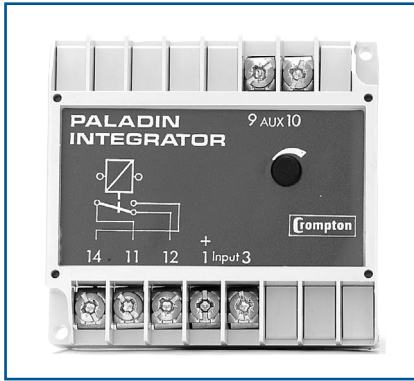

Information provided by:
MetersUSA
Meters@MetersUSA.com
WWW.MetersUSA.com

Linear Integrator Pulsed Output Transducer

Typical applications result in pulses proportional to kilowatt-hours, ampere hours, litre-hours etc., depending on the transducer or transmitter used. Accepts inputs in the form of a process signal derived from transducers or transmitters and integrates them with respect to time, to produce a pulsed output via volt free relay contacts. Converts a D.C. input into a pulsed kilowatt hour and ampere hour measurement output.

Specification

Inputs:	0/1mA, 4/20mA, 0/5mA, 0/10mA, 0/20mA, 0/1V D.C., 0/10V D.C.
Output:	Volt free relay contacts.
Pulse rate:	Minimum 100/hour maximum 10,000/hour, specify.
Auxiliary Power:	63.5, 110, 120, 139, 208, 220, 240, 277, 380, 415, 440, 480V A.C.

Product Code – Linear Integrator

Input	Pulses per hour	A.C. Aux Power	Catalogue No.	Connection Diag.
0/1mA	Specify	120V	253-TIK*-FAPO-DG	13



Signal Isolator

The signal isolator is designed for use in signal transmission and processing applications to prevent noise and interference caused by ground loops between signal source and the measuring device. The isolator provides galvanic high voltage isolation between source and measuring device.

Specification

Input/Output Ratio:	1 to 1
Max Input/Output:	20mA D.C.
Accuracy:	0.2% at 250 ohms
Isolation:	660V A.C., 930V D.C. continuous
Test Voltage:	1.5kV at 50Hz for 1 minute
Load Range:	0-500 ohms @ 20mA D.C.
Output Voltage:	I out x R Load limited to 15V
Input Voltage:	Typically I x (load + 200Ω) limited to 18V
UL File Number:	E149713N
CSA File Number:	LR52592

Product Code – Signal Isolator

Input D.C.	O/P D.C.	Catalogue No.	Connection Diag.
20mA	0/20mA	250-ISA*-HF	5

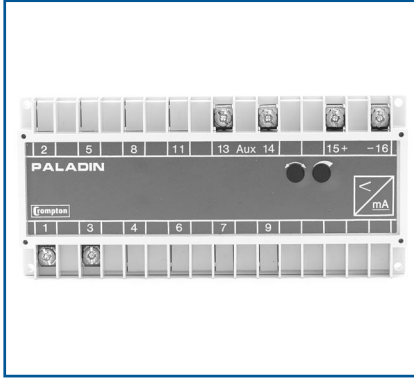

D.C./D.C. & Temperature

D.C. input versions accept signals over a wide range providing galvanic isolation between the input and output signal. Output is directly proportional to the input. Thermocouple models also incorporate cold junction compensation for all base metal Thermocouples, and Thermocouple break protection. Suitable for data acquisition and data control monitoring.

Specification

Inputs:	D.C. Voltage: Any value between 10mV to 600V D.C. Current: Any value between 100µA to 10A
Thermocouple Models:	A range of temperature transmitters suitable for use with a variety of thermocouples.
Inputs:	The most popular types are: J-Fe/Const 0-700°C K-NiCr/NiA 0-1200°C T-Cu/Cn0-200°C
Auxiliary Power:	A.C.: 63.5, 110, 120, 220, 240, 380, 415, 440 and 480V D.C.: 12, 24, 48, 110, 120 or 135V

Information provided by:
MetersUSA
Meters@MetersUSA.com
WWW.MetersUSA.com

Product Codes – D.C./D.C. and Temperature Transducer

Input	O/P D.C.	A.C. Aux Power	Catalogue No.	Connection Diag.
D.C. Current	0/1mA	120V	256-TTA*-**FA-DG	18
D.C. Millivolts	0/1mA	120V	256-TTM*-**FA-DG	18
D.C. Voltage	0/1mA	120V	256-TTV*-**FA-DG	18
Thermocouple				
Type K	0/1mA	120V	256-TTN*-KTFA-DG	18
Type T	0/1mA	120V	256-TTC*-TTFA-DG	18
Type J	0/1mA	120V	256-TTF*-JTFA-DG	18



Resistance Transmitter

A simple and convenient way of measuring and transmitting values of temperature in the form of a load independent D.C. signal. They detect varying resistance due to temperature change at the RTD (Resistance Temperature Detector). Designed for platinum (Vt.100), Copper (Cu 10) or Nickel (Ni100) RTDs.

Specification

Input:	100Ω Platinum - (Pt100), 10Ω Copper, 100Ω Nickel
Outputs:	0/1mA, 0/5mA, 0/10mA, 0/20mA, 4/20mA,
Auxiliary:	A.C.: 110, 120, 220, 240, 380, 415V D.C.: 12, 24, 48, 110, 120 or 135V

Product Codes – Resistance Transmitter

Input	O/P D.C.	A.C. Aux Power	Catalogue No.	Connection Diag.
10 Ohms copper RTD	0/1mA	120V	253-TRR*-R1FA-DG	17
100 Ohms VT RTD	0/1mA	120V	253-TRR*-R2FA-DG	17

Ordering Information

Input span can be specified in temperature or resistance. The resistance value between lowest and highest temperature being measured must be within limits stated.

Platinum:	20Ω minimum span, 200Ω maximum span
Copper:	2Ω minimum span, 20Ω maximum span
Nickel:	20Ω minimum span, 200Ω maximum span



Power Transducers

A wide range of transducers to measure all forms of power, in single or 3 phase balanced or unbalanced, 3 or 4 wire systems. These Transducers utilise the well proven 'time division multiplication' method of measuring instantaneous power over a wide range of input waveforms. In the self powered version the system voltage provides both power supply and an input to the voltage modulation circuit of an oscillator. Square wave pulses from a multi-vibrator circuit with a mark-space ratio varied by the measured voltage, and amplitude varied by the measured current, are fed to an integrator and an output amplifier circuit. The D.C. milliamp signal produced is therefore directly proportional to the power input. All inputs are isolated by the use of transformers. For large voltage variations use the auxiliary powered versions. Self powered units permit voltage variations up to +20% of the nominal input. Measures both import and export power.

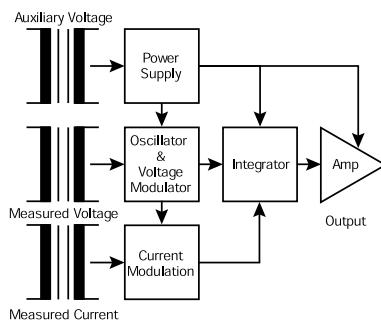

Information provided by:
MetersUSA
Meters@MetersUSA.com
WWW.MetersUSA.com

Specification

Input Voltage:	63.5, 110, 120, 150, 208, 220, 240, 277, 380, 415, 480V
Current:	1, 5, 10A
Frequency:	50 or 60 or 400Hz
Outputs:	0/1mA, 0/5mA, 0/10mA, 0/20mA, 4/20mA
Auxiliary Power:	Self Powered
A.C.:	63.5, 110, 120, 150, 208, 220, 240, 277, 380, 415, 480V
D.C.:	12, 24, 48, 120, 135V

Product Codes – Watt Transducer

	Catalogue No.	Connection Diag.
Single Phase	256-TWK	14
3 Phase 3 Wire Balanced Load	256-TWL	19
3 Phase 4 Wire Balanced Load	256-TWH	24
3 Phase 3 Wire Unbalanced Load	256-TWM	20
3 Phase 4 Wire Unbalanced Load	256-TWN	35
3 Phase 3 Wire Balanced Load (2 Voltage connections)	256-TWS	38

Product Codes – VAr Transducer

Single Phase	256-TXK	14
3 Phase 3 Wire Balanced Load	256-TXG	34
3 Phase 4 Wire Balanced Load	256-TXH	42
3 Phase 3 Wire Unbalanced Load	256-TXM	20
3 Phase 4 Wire Unbalanced Load	256-TXN	40

Product Codes – VA Transducer

Single Phase	256-TYK	14
3 Phase 3 Wire Balanced Load	256-TYG	41
3 Phase 4 Wire Balanced Load	256-TYH	42
3 Phase 3 Wire Unbalanced Load	256-TYM	20
3 Phase 4 Wire Unbalanced Load	256-TYN	35

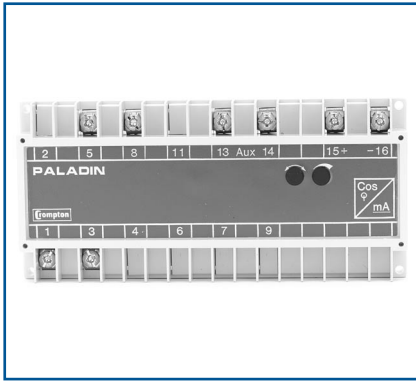

Information provided by:
MetersUSA
Meters@MetersUSA.com
WWW.MetersUSA.com

Power Factor and Phase Angle

A range of power factor and phase angle transducers with a linearised output.

Product Codes – Power Factor Transducer (for Digital Meters & Systems)

3 Phase 3 or 4 Wire Balanced Load.

Power Factor	Catalogue No.	Connection Diag.
Single Phase 0.5/1/0.5	256-TDSU	43
Single Phase 0/1/0	256-TDCU	43
Single Phase 1/0/1/0/1	256-TDAU	43
3 Phase 3 or 4 Wire Balance Load 0.5/1/0.5	256-TDTU	45
3 Phase 3 Wire Balance Load 0/1/0	256-TDEU	46
3 Phase 3 or 4 Wire Balance Load 1/0/1/0/1	256-TDBU	46

Note: These products are only suitable for 50Hz or 60Hz operation.

Product Codes – Phase Angle Transducers Single Phase

3 Phase 3/4 Wire Balanced Load 2 or 4 Quadrant

Phase Angle	Catalogue No.	Connection Diag.
Single Phase 60/0/60 75/0/36 0.5/1.0/0.5 or 0.2/1/0.8	256-TPSU	14
Single Phase -180°/0/180°	256-TPAU	14
3 Phase 3 or 4 Wire Balanced Load 0.5/1/0.5 or 0.2/1/0.8	256-TPTU	42
3 Phase 3 or 4 Wire Balanced Load -180°/0/180°	256-TPBU	19

Product Codes – Power Factor Transducer (Suits Analogue Indicators) Single Phase

3 Phase 3 or 4 Wire Balanced Load.

Accuracy +/- 3% of Span, i.e. 0.03 counts on 0.5/1/1/0.5 model.

Power Factor	Catalogue No.	Connection Diag.
Single Phase - 0.5/1/0.5	256-TFSU	14
Single Phase - 0/1/0	256-TFCU	14
Single Phase - 1/0/1/0/1	256-TFAU	14
3 Phase 3 or 4 Wire Balanced Load 0.5/1/0.5	256-TFTU	42
3 Phase 3 Wire Balanced Load 0/1/0	256-TFEU	19
3 Phase 3 Wire or 4 Wire Balanced Load 1/0/1/0/1	256-TFBU	19

Note: These products are only suitable for 50Hz or 60Hz operation.

Product Code – Phase Relationship Transducer

Phase Relationship	Catalogue No.	Connection Diag.
Measures the phase relationship between two systems (voltage inputs)	256-TPDU	36

Conversion to P.F.

The transducer output, if displayed on an analogue meter, produces an inconvenient non-linear scale. Computer users may find the need for a linearising program. Other transducers are available from Crompton Instruments with a linearised output if required.

